

SINGER
15-91

To all whom it may concern:

The placing or renewal of the name "Singer" (Reg. U. S. Pat. Off.) or any of the trade marks of The Singer Manufacturing Company on any machine that has been repaired, rebuilt, reconditioned or altered in any way whatsoever outside a Singer factory or an authorized Singer agency is forbidden.

Purchasing of Parts and Needles

Supplies of parts and needles for Singer machines can be purchased at any Singer Shop for the Manufacturing Trade or ordered by mail. If orders are sent by mail, money or a post office order covering their value, including postage, should be enclosed and the order will then be promptly filled and forwarded by mail or express.



Genuine Singer Needles should be used in Singer Machines. These Needles and their Containers are marked with the Company's Trade Mark "SINGER." 1

Needles in Containers marked "For Singer Machines" are not Singer made needles. 2

ADJUSTERS MANUAL FOR MACHINE 15-91

P. G. BUILT-ON MOTORS AND KNEE
AND TREADLE CONTROLLERS

These Instructions Also Apply To The
STITCHING MECHANISM
OF
MACHINES 15-88, 15-89 and 15-90

FOR INFORMATION RELATIVE TO
B. R. MOTORS FOR MACHINE 15-90
See Form 18573, "The Care and Use of
SINGER B. R. SEWING MOTORS"

INDEX

	PAGE
ARM SHAFT	
To REMOVE AND REPLACE ARM SHAFT	31-35
BALANCE WHEEL	
To REMOVE AND REPLACE BALANCE WHEEL	21
To DISASSEMBLE AND REASSEMBLE BALANCE WHEEL	21, 22
BOBBIN WINDER	
To ADJUST BOBBIN WINDER.	31
CONTROLLERS	
DESCRIPTION AND ADJUSTMENT OF KNEE AND TREADLE CONTROLLERS	12-15
To REMOVE AND REPLACE KNEE CONTROLLER	5, 6
To REMOVE AND REPLACE TREADLE CONTROLLER	6, 7
ELECTRICAL CONNECTIONS	
ELECTRICAL CONNECTIONS	4, 5
To INSPECT ELECTRICAL CONNECTIONS	9-15
FEEDING MECHANISM	
To ADJUST POSITION OF FEED DOG IN THROAT PLATE SLOTS	29
To RAISE OR LOWER FEED DOG	29
To ADJUST PRESSER BAR	28
LUBRICATION	
To OIL THE MACHINE	36, 37
To LUBRICATE THE MOTOR	20
MOTOR	
CAUSES OF INCORRECT SPEED OR FAILURE TO RUN	7, 8
CIRCUITS ON WHICH SINGER P. G. MOTORS CAN BE OPERATED	3
To REMOVE MOTOR FROM MACHINE	16
To DISASSEMBLE THE MOTOR	16-18
To REASSEMBLE AND REPLACE THE MOTOR	18-20
SINGERLIGHT	
To DISASSEMBLE AND REASSEMBLE SINGERLIGHT	10-11
SINGERLIGHT FAILS TO LIGHT	11
To REMOVE AND REPLACE BULB	11
STITCHING MECHANISM	
To REMOVE AND REPLACE THE SHUTTLE	23
To TIME THE SHUTTLE	23, 24
To REMOVE AND REPLACE THE SHUTTLE DRIVER	26
To ADJUST SHUTTLE DRIVER CUSHION SPRING	28
To SET NEEDLE BAR AT CORRECT HEIGHT	25
To REMOVE AND REPLACE OSCILLATING SHAFT	27
To REMOVE AND REPLACE OSCILLATING SHAFT CRANK	27
THREAD CONTROL MECHANISM	
To ADJUST TENSION AND REGULATE ACTION OF THREAD TAKE-UP SPRING	29, 30
To REMOVE AND REPLACE THREAD TENSION PARTS	30

SINGER P. G. BUILT-ON MOTORS FOR MACHINE 15-91

The Singer P. G. Motors, which are built on the No. 15-91 lock stitch, reversible feed, family sewing machines, are operated on either alternating current or direct current, but the motor **rating** must be selected to correspond to the electric current available. Therefore, before connecting the motor to the electric service line, take a copy of the data stamped on the motor name plate and check it with your local Electric Company to make sure that the volts and cycles agree.

Carefully observe the above instructions when selecting the motor from the following list:

Volts	Current	Motor Catalog No.
32	Direct Current Only	P. G. 3
50	Direct Current and 25 to 75 Cycles Alternating Current	P. G. 5
95-100		P. G. 6
100-110		P. G. 7
115-125		P. G. 8
150-165		P. G. 9
200-220		P. G. 10
210-230		P. G. 11
230-250		P. G. 12
130-145		P. G. 15
100-110		80 to 100 Cycles Alternating Current
200-220	P. G. 90	
230-250	P. G. 92	

Only rarely is a supply of electricity found where none of the above listed motors is suitable. In such case the factory should be consulted regarding the possibility of supplying a special motor.

To Ensure Correct Demonstration of Machine

Be sure that the voltage range, specified on the name plate of the motor, is within the range of voltage of the electric service line. **A higher service line voltage will produce excessive speed and will cause damage to the motor, while a lower voltage will cause the motor to operate too slowly.**

Electrical Connections for Machine 15-91 and Singer P. G. Built-On Motor

To facilitate the proper connection of the leads to the terminals, the two outer connecting pins, Nos. 1 and 3, are dis-

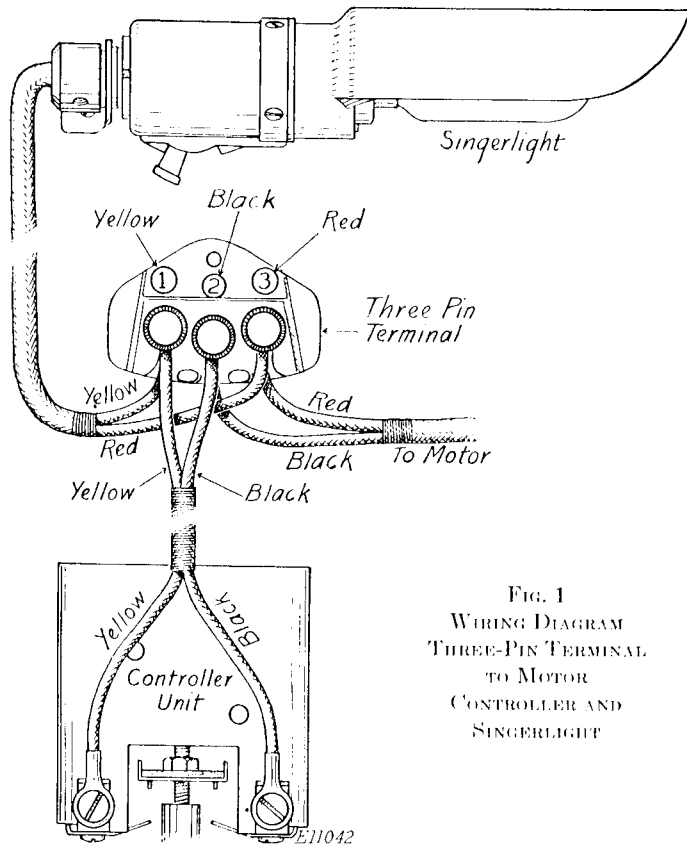

FIG. 1
WIRING DIAGRAM
THREE-PIN TERMINAL
TO MOTOR
CONTROLLER AND
SINGERLIGHT

tinguished by a yellow and red spot, respectively, directly above the pins. The middle pin, No. 2, is uncolored. The leads for these pins have tracer threads of corresponding colors running through them. The solid black lead is for attachment to the middle, uncolored, pin No. 2.

The connections are made as follows:

Motor Leads—Fasten the lead with the **red** tracer thread to the **red** pin No. 3, and fasten the solid **black** motor lead to the **middle** pin No. 2, as illustrated in Fig. 1.

Singerlight Leads—Fasten the lead with the **yellow** tracer thread to the **yellow** pin No. 1, and fasten the lead with the **red** tracer thread to the **red** pin No. 3.

Controller Leads—Fasten the lead with the **yellow** tracer thread to the **yellow** pin No. 1, and fasten the **black** lead to the **uncolored** pin No. 2.

The lead cord, for the power supply, is provided with a plug for the electric outlet, and a plug for the three-pin terminal. The three-pin terminal plug is marked with the numerals 1, 2 and 3 to correspond with the pin numbers of the three-pin terminal. The power leads are connected to terminals 1 and 3 of the three-pin terminal plug. These two wires are knotted together as shown in Figs. 7 and 8, on page 12.

To Remove and Replace Knee Controller and Knee Controller Leads in Cabinet 40

Disconnect controller leads from pins Nos. 1 and 2 of the three-pin terminal. Draw the leads down through lifting plate

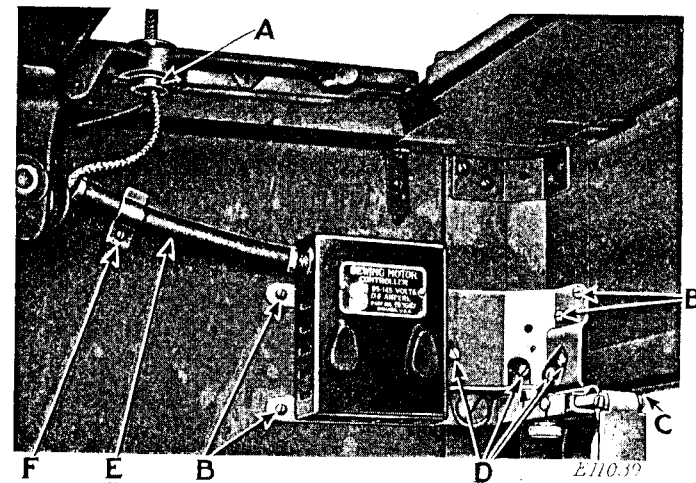

FIG. 2. KNEE CONTROLLER IN CABINET 40

bushing (A, Fig. 2). Remove cable housing (E) from clip (F). Remove the four screws (B). When replacing, fasten knee controller bracket to inside of cabinet by means of the four screws (B). Position the bracket with its openings directly above the

four screws in the cabinet as shown at (D). This brings knee controller lever just below the front of the cabinet as shown by (C). Put cable housing (E), containing controller leads, in clip (F). Pass the controller leads up through bushing (A) and attach controller leads to three-pin terminal as indicated by Fig. 1, Wiring Diagram.

To Remove and Replace Treadle Controller on Stand 46913 and Controller Leads in Cabinet 404

Disconnect the controller leads from pins Nos. 1 and 2 of three-pin terminal. Draw controller leads down through lifting plate bushing (Q, Fig. 3). Remove cable housing (H) from clip (P). Loosen nut (K) and unscrew pitman rod (J) from connection (L). Remove nut and screw (N) which fasten controller bracket (O) to treadle frame. When replacing, attach bracket (O) to treadle frame by means of screw and nut (N). Attach pitman rod (J) to connection (L) by screwing upper end of pitman rod into base of connection as shown in Fig. 3. Tighten nut (K) against base of connection (L). Put long cable housing (H) in clip (P) and place short cable housing (G) above housing (H) as shown in Fig. 3. Pass controller leads up through bushing (Q) and attach controller leads to three-pin terminal as shown by Fig. 1, Wiring Diagram.

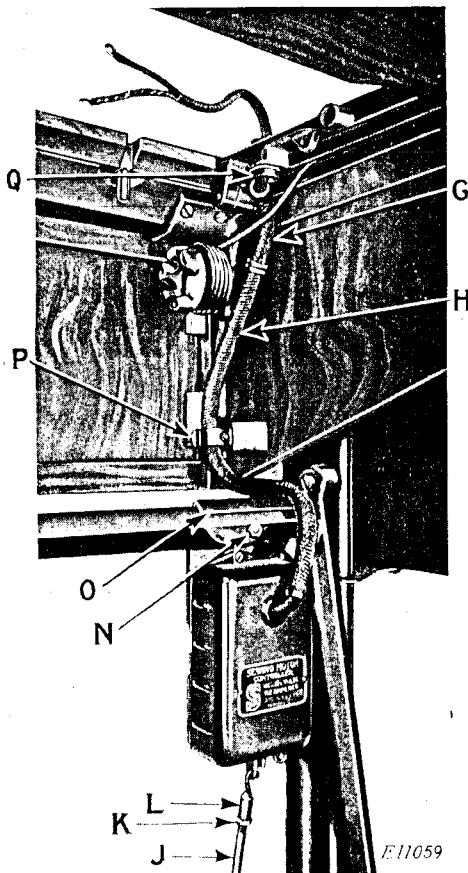

FIG. 3. TREADLE CONTROLLER ON STAND 46913 AND CABINET 404

NOTE—When installing the sewing machine in Cabinets 40 and 401, insert the hinge connections in the machine bed as far as they will go, and securely tighten the set screw at each hinge connection in machine bed.

CAUSES OF TROUBLE WITH MACHINE 15-91

Failure to Start or Incorrect Speed

The machine may fail to start or may run too fast or too slow due to damage after final factory inspection, improper selection of motor, or other causes as follows:

Causes of Low Speed or Failure to Run

1. Heavy or Gummed Lubricant. If the sewing machine has not been run for some time, the lubricant may have become heavy, thereby reducing normal speed. To overcome this, run the machine unthreaded for a few minutes with the presser foot raised. If a poor grade of lubricant has been used and has become gummy, wash off all of the lubricant from the sewing machine, with kerosene, dry with a clean cloth and re-lubricate with Singer Sewing Machine Oil.

2. Too Much Pressure on the Presser Foot. Pressure on the presser foot should be as light as possible without interfering with the feeding of the material.

3. Machine Binds. This may be determined by turning over the balance wheel, slowly, by hand, in the direction for sewing. If the machine binds, do not attempt to run it but examine all of the working parts and correct the damage if any is found. A dry machine will bind and should be lubricated, using Singer Sewing Machine Oil. If the **motor** binds, be sure to fill the grease cups with Singer Motor Lubricant. If this does not improve the condition, it indicates that the armature shaft is not properly placed in its bearings, or that the armature shaft is bent. In the latter case, the armature should be replaced.

4. Electric Current Not Turned On.

5. Loose or Broken Electrical Connections. Examine carefully all plugs and connections in accordance with instructions on pages 9 to 15, inclusive, and make sure that there are no broken wires and that all screwed and soldered connections are tight. If the pins of the three-pin terminal plug, slightly spread apart the prongs of the pins (D, Fig. 12).

6. Motor Not Suited for Electric Supply. Make sure that the volts and cycles, stamped on the name plate of the motor, agree with the electric current available. If the motor is run on a voltage lower than that stamped on the name plate, the speed of the motor will be too slow. If the motor is run on a voltage higher than that stamped on the name plate, the speed of the motor will be too fast and cause damage. See "Singer P. G. Built-On Motors," page 3.

7. Dirty Commutator. See that there is no carbon or grease and that it is smooth on the commutator. (See "Inspect and Clean the Armature," page 17). The commutator can easily be cleaned with a rubber eraser. Never use anything else on a small motor commutator.

8. Carbon Brushes Not Making Contact. This may be due to brushes sticking in the brush tubes, or to grease on the commutator. See "Remove Brushes," page 16, and "Replace Brushes," page 20.

9. Armature Binding. To determine this, remove the motor cover in accordance with instructions on page 16, then, to disengage the motor from the balance wheel, remove the balance wheel in accordance with instructions on page 21. The removal of the motor cover exposes the free end of the armature. With the fingertips, rotate the armature.

Causes of Binding:

- a. Foreign substances in the armature shaft bearings.
- b. Lack of lubrication. Grease wicks and tubes may be dry.
- c. Brush tubes rubbing on the commutator. This might occur in case the brush tubes are not properly positioned in the insulating bushings. See "Remove and Replace Brush Tubes," page 18.
- d. Armature Striking field coils.

10. Broken Armature Wires. See that the fine wiring on the end of the armature is not broken. See "Inspect and Clean Armature," page 17.

11. Controller Not Properly Adjusted. See instructions on pages 12 to 15, inclusive.

To Inspect Electrical Connections

The motor, three-pin terminal and Singerlight may be removed as a unit, as shown by Fig. 4, as a matter of convenience when

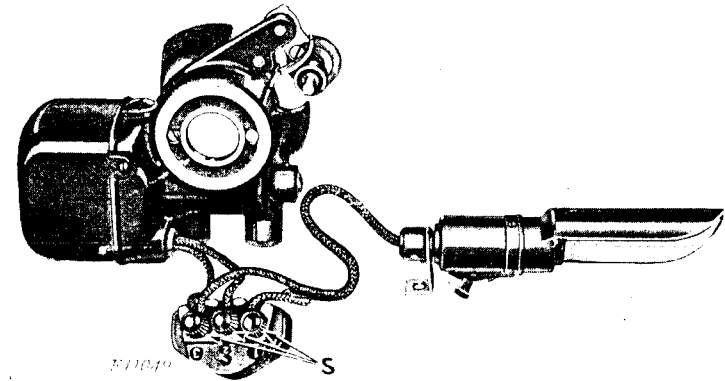

FIG. 4. MOTOR, THREE-PIN TERMINAL AND SINGERLIGHT

inspection of electrical connections is to be made. Take out screw (F, Fig. 12) and remove the three-pin terminal from its bracket. Disconnect the controller leads from terminal pins Nos. 1 and 2. Remove arm side cover to expose screw (B, Fig. 12) which fastens the Singerlight to the sewing machine. Remove screw (B, Fig. 12) and Singerlight.

Remove the balance wheel, as instructed on page 21, to gain access to the two screws (A, Fig. 12) which fasten the motor frame to the machine arm. Remove the two screws (A, Fig. 12) and take the motor frame, with motor attached, from the machine.

Three-Pin Terminal. Inspect the connections at the three thumb nuts (S, Fig. 4). See that the thumb nuts are screwed down firmly to ensure tight connections. Each of the three pins is provided with a washer. See that this washer is, in each case, placed above the wire or wires before tightening the thumb nuts.

Motor. Disconnect the motor leads from pins Nos. 2 and 3 of the three-pin terminal.

Inspect the soldered connections (R, Fig. 14) at the brush tubes. See "Replace Field Core with Coils," page 18.

Singerlight. Disconnect the Singerlight leads from pins Nos. 1 and 3 of the three-pin terminal. Draw the reflector (A, Fig. 5)

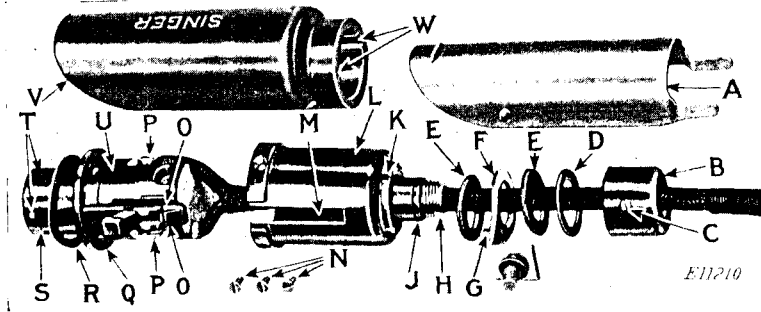

FIG. 5. SHOWING SCREW CONNECTIONS OF SINGERLIGHT

from Singerlight shade (V). Turn the shade until the pins (T) on Singerlight lamp socket (S) reach the slots (W) on the inside of Singerlight shade base, and draw the shade from the lamp socket. Loosen screw (C) in Singerlight nipple cap (B), and unscrew the nipple cap. Draw the nipple cap (B) along the leads and away from the Singerlight shell (L) as shown in Fig. 5. Remove the three screws (N) which fasten the shell (L) to the lamp socket body (U), and draw the shell (L), fibre washer (D), Singerlight bracket (F) and the two felt washers (E), along the leads and away from the lamp socket body (U) as shown in Fig. 5.

Inspect the two screw connections (P). See that they are screwed down firmly and that the wires are unbroken.

When reassembling, push the shell (L) tight against the flange (Q) of the lamp socket body (U) and with the slot (M) engaged by the grooves (O) in the cover plate. Insert and tighten the three screws (N). Put the felt washers, bracket and fibre washer on the screw nipple bushing (J) and against the base of the shell (L) in the following order and as indicated in Fig. 5:

Felt washer (E), Singerlight bracket (F) with bracket pin (G) in notch (K) of shell (L); next put the second felt washer (E) and, last, the fibre washer (D) on the bushing (J). When the washers and Singerlight bracket are placed, as above, on screw nipple bushing (J), screw the nipple cap (B) firmly onto the screw nipple (H), and tighten screw (C).

Before replacing Singerlight shade (V) and reflector (A), be sure to have the spring washer (R) on the lamp socket (S), as shown in Fig. 5.

NOTE—The essential difference between the latest type Singerlight (covered by the foregoing description and shown in Fig. 5) and the previous type, is that the older type of Singerlight is arranged with the switch handle at the top instead of, as at present, with the handle at the bottom. Another difference is that the bracket pin (G), of the previous type Singerlight, engages one of four notches in the nipple cap (B) instead of notch (K) in the shell, as shown in Fig. 5.

Singerlight Fails to Light

This may be due to any of the following causes:

1. Electric current not turned on.
2. The Singerlight bulb may be broken or burned out.
3. Singerlight switch not turned on.
4. Loose or broken connections. See that the two thumb nuts at terminals 1 and 3, respectively, which fasten the Singerlight wires to the terminal posts, are properly tightened.

NOTE—The voltage marked on the Singerlight bulb must be within the range stamped on the name plate of the electric meter installed by the local Electric Light Company.

In ordering bulbs from the factory, specify Singerlight Lamp, Part No. 194120, and **state the voltage of the lamp required.**

To Remove and Replace the Bulb

Do not attempt to unscrew the bulb. It is of the double contact bayonet candelabra type and does not unscrew. To remove the bulb, press it into the socket and turn it counter-clockwise.

To replace the bulb, press it into the socket and turn it clockwise until the bulb pin (B, Fig. 6) enters the notch in the socket.

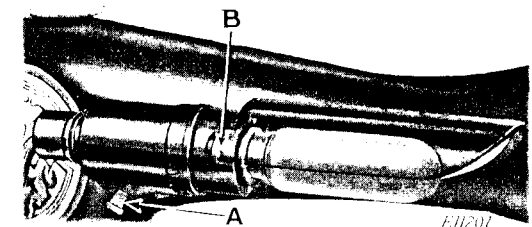

FIG. 6. TO REMOVE AND REPLACE BULB

Three-Pin Terminal Plug, shown in Figs. 7 and 8, has three sleeves (W, Fig. 8) which are engaged by the three pins (D, Fig. 12) when the plug is pushed into the three-pin terminal block (E, Fig. 12).

Make sure that these connections are tight and that the hexagon heads of these sleeves are properly seated in the plug, as shown by Fig. 8.

Note that the two wires are knotted together as shown by (V, Figs. 7 and 8). This is to prevent strain or breakage in case the plug is pulled from the three-pin terminal by grasping the wires instead of the plug. Therefore, the knot is placed so that it, instead of the connections, bears the strain when the plug is drawn from the terminal.

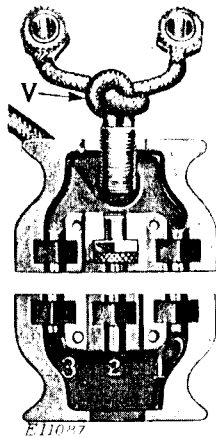

FIG. 7
TERMINAL PLUG
CONNECTIONS REMOVED

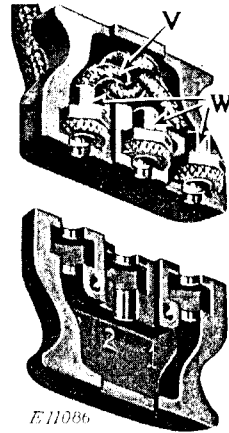

FIG. 8
TERMINAL PLUG
CONNECTIONS IN PLACE

Electric Outlet Plug. See that the wires are closely looped about the screw connections, and that the screws are firmly tightened.

Singer Carbon Controller

The following instructions cover the Knee Controller, Fig. 10 (used in connection with Cabinet 40) and the Treadle Controller Fig. 11 (used in connection with Cabinet 404 and Stand 46913).

See instructions for installation, pages 5, 6 and 7.

All Carbon Resistance Units, after mounting upon the controller mechanism, are carefully adjusted at the factory, and this adjustment can not change unless some part of the mechanism is bent or broken. In case adjustment has been disturbed, or it has been found necessary to substitute a new unit, adjustment should be made as instructed on pages 14 and 15.

The Singer Carbon Controller affords complete control of the motor in starting, operation at various speeds, and stopping when desired. Should it fail to satisfactorily perform any of these duties, the trouble may be located by the following procedure:

1. Motor Fails to Start

Operate the lever of the knee controller, or the treadle of the treadle controller, to make sure that the mechanism does not bind.

Knee Controller. To inspect and clean knee controller mechanism, remove complete knee controller from cabinet as instructed on pages 5 and 6. Take out thumb screw (J, Fig. 9) and remove

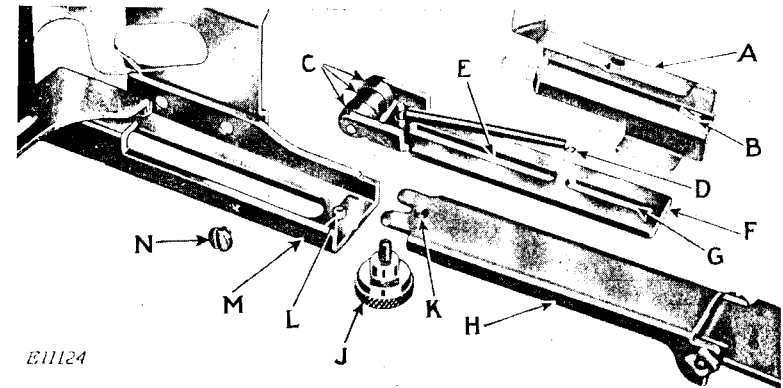

FIG. 9. KNEE LEVER SLIDE PARTS DISASSEMBLED

knee lever (H, Fig. 9) from the slide housing (M, Fig. 9). Take out screw (N, Fig. 9) and remove the slide cover (A, Fig. 9) after disconnecting spring (D, Fig. 9) from hook (B) on the inside of cover (A). Inspect the slide rollers (C) making sure that they revolve freely. Before reassembling, clean knee lever slide parts and apply a small quantity of Singer Motor Lubricant to the slide (F) at all points where it comes in contact with slide housing (M), also on the edges of the slot (G) which is engaged by stop pin (L), and on the surfaces of, and between, the three slide rollers (C). Also apply a small quantity between fulcrum lever (S2, Fig. 10) and the controller frame, and between screw head (S, Fig. 10) and fulcrum lever (S2, Fig. 10).

When reassembling, put slide (F) in slide housing (M) with rollers (C) facing upward to engage the knee lever end of the fulcrum lever, and with stop pin (L) in slot (G) of the slide. Next put the slide cover (A) in place, having the upper end of spring (D) hooked to the inside of cover at (B), and insert and tighten screw (N). Fasten knee lever (H) to slide (F) by inserting thumb nut (J) through slot (E) of the slide, and into screw hole (K) of the knee lever (H), then tighten thumb nut (J).

To Inspect Treadle Controller, remove it from Stand 46913 and remove the leads from Cabinet 404, as instructed on pages 6 and 7.

To Inspect Carbon Controller Unit of Knee Controller and of Treadle Controller, remove screw at (P, Figs. 10 and 11) to remove the controller cover, and inspect the wires and connections at (Q, Figs. 10 and 11).

2. Motor Fails to Operate at All Speeds

Emergency Adjustment of Carbon Resistance Unit

(a) When the knee lever (S2) of the knee controller is released—or the yoke (X) of the treadle controller is against the stop

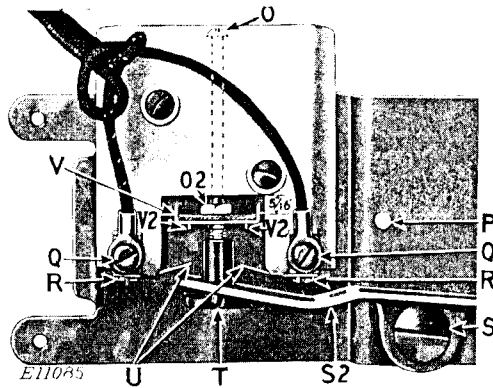

FIG. 10. KNEE CONTROLLER WITH COVER REMOVED

screws (W)—to stop the motor, the face of the bakelite strip, between the cross slide (V) and nut (O2), should be about $\frac{5}{16}$ inch from the flat face of the porcelain as shown in Figs. 10 and 11. If the distance is not $\frac{5}{16}$ inch, release insulating nut (T, Figs. 10 and 11) from its seat by pushing on the end of pull rod at (O), and turn nut (T) until correct adjustment is obtained.

Be sure that nut (T) is properly seated on the end of fulcrum lever (S2) of knee controller, or in yoke (X) of treadle controller.

Do not disturb the adjustment of nut (O2, Figs. 10 and 11).

(b) **Depress the Knee Lever (S2)** to the fullest extent for full speed position of the **knee controller**.

Pull the Yoke (X) as far as it will go, away from the stop screws (W) and against the tension of the springs (Y), for full speed position of the **treadle controller**.

At this position, in each case, the points (V2) of the cross slide (V) should close the two short circuiting strips (U) and make

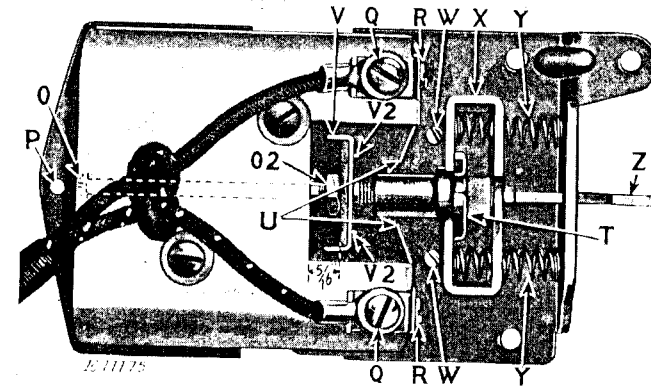

FIG. 11. TREADLE CONTROLLER WITH COVER REMOVED

positive contact. If this contact is too heavy, the short circuiting strips (U) may be bent or broken.

(c) If the short circuiting strips (U) 193384 are found to be broken, they may be replaced after removing the screws (R). Adjust as instructed under (b).

3. Motor Fails to Stop

Knee Controller. See that the knee lever (H, Fig. 9) is fully released, with the stop pin (L, Fig. 9) at the extreme lower end of slot (G, Fig. 9) of slide (F, Fig. 9), and see that insulating nut (T, Fig. 10) is properly seated in end of lever (S2, Fig. 10).

Treadle Controller. See that the yoke (X, Fig. 11) is at the stop position against the two screws (W, Fig. 11), and see that insulating nut (T, Fig. 11) is properly seated in yoke (X).

Check the controller adjustment as explained under part 2.

Replace controller cover and tighten screw at (P, Figs. 10 and 11).

To Adjust Length of Knee Control Lever

This lever is adjustable for length to the limits of slot (E, Fig. 9) of slide (F). Loosen thumb screw (J, Fig. 9) and slide knee lever (H, Fig. 9) inward or outward in slide housing (M, Fig. 9) for length to suit operator, then tighten thumb screw (J).

To Remove the Motor From the Machine

Take out screw (F, Fig. 12) and remove the three-pin terminal (E) from the terminal bracket.

Disconnect motor leads from the three-pin terminal. Remove balance wheel as instructed on page 21.

Take out the two screws (A) and remove, from the machine, motor frame with motor attached.

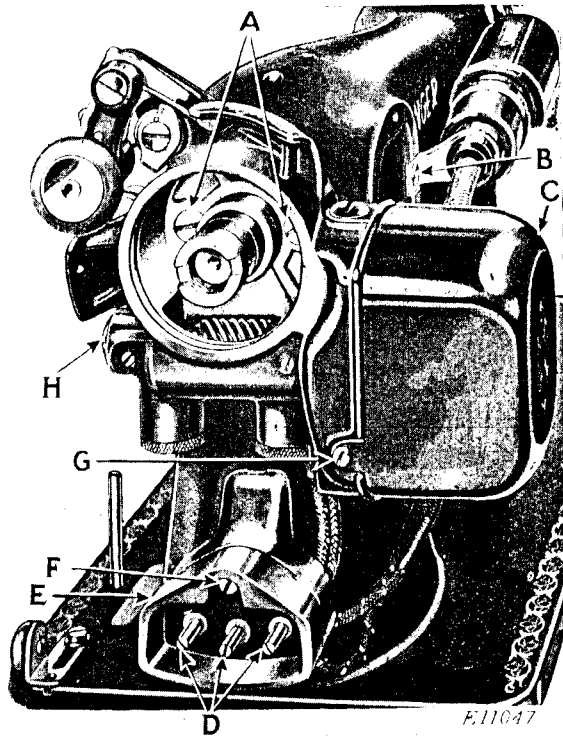

FIG. 12. MACHINE AND MOTOR
(BALANCE WHEEL REMOVED)

To Disassemble the Motor

Remove Motor Cover. Loosen the two screws, one of which is shown at (G, Fig. 12) and remove motor cover (C, Fig. 12) by pulling, and at the same time, rocking it up and down slightly, being careful to prevent inside of cover damaging the field coils.

Remove Brushes. Take out screw caps (M, Fig. 14). When screw caps are removed, the brush springs may protrude from the screw holes, and brushes can then easily be withdrawn. However, should difficulty be experienced in removing the brushes, this can be done conveniently after removal of the armature in accordance with "Remove Armature" following. It is advisable to mark the brushes at (P1 and P2, Fig. 14) to make sure that they will be replaced in the same relative position as before removal.

Remove Armature. Remove the brushes in accordance with preceding paragraph. Loosen the two set screws (E, Fig. 13) in

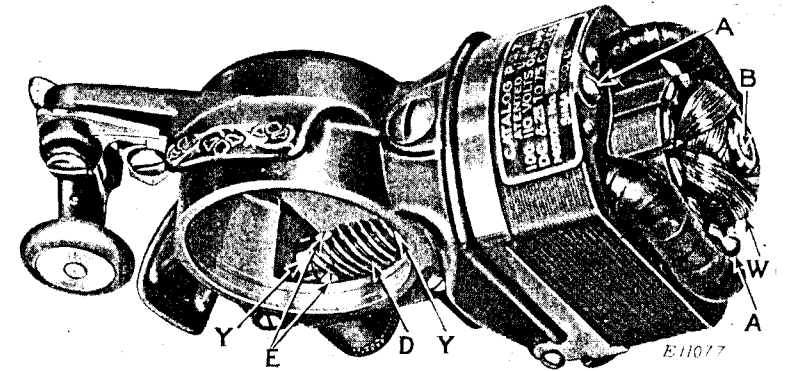

FIG. 13. MOTOR WITH COVER REMOVED

the spiral gear (D, Fig. 13) so that the armature shaft can be withdrawn from its bearings. Remove the armature (W, Fig. 13).

Inspect and Clean the Armature. Inspect the armature winding, making sure that the enamel insulation on the winding is not damaged. Damage to the enamel insulation will prevent proper operation of the motor. If any wires are broken, bare or burned, return the complete motor to the factory for repairs.

If wiring is not damaged, clean commutator (V, Fig. 14) with a dry, clean cloth before assembling motor. If it is impossible to get the commutator bright by this means, use an ordinary rubber eraser. **Never use anything else on a small motor commutator.**

Remove the Field Core with Coils—Loosen the two screws (A, Fig. 13) and remove the field core (S, Fig. 14) from the commutator end cover which, in this case, is part of the motor frame. The removal of the field core must be done carefully to prevent damage to the field coil insulation, and to prevent strain at the soldered brush tube connections (R, Fig. 14).

Clean Brushes and Brush Tubes. Thoroughly clean the carbon brushes (O, Fig. 14), inner walls of brush tubes and inside of end covers, with a dry, clean cloth.

Inspect Wire Connections to Brush Tubes. Examine both field wire connections (R, Fig. 14) at the brush tubes. If broken, these connections should be securely soldered to the lugs of the brush tubes. Any loose strands of wire should be cut off.

Remove and Replace Brush Tubes. After the brushes and brush tubes have been cleaned, the brushes should slide freely in the brush tubes. If they do not, the brush tubes should be replaced by new ones. The new brush tubes must be replaced in the same manner as the old tubes, viz., firmly positioned in the insulating bushings (Z, Fig. 14), and with the field leads properly soldered to the lugs of the new tubes, as shown by (R, Fig. 14).

Remove and Replace Insulating Bushings. If the threads in the insulating bushings (Z, Fig. 14) and on screw caps (M, Fig. 14) become stripped, these parts should be replaced by new ones. When these bushings require replacement, the brush tubes also should be replaced with new ones. Do not attempt to use the old brush tubes in the new bushings. Loosen the two screws at (Q, Fig. 14) to release the bushings (Z, Fig. 14). When the new bushings are in place, tighten the screws (Q, Fig. 14).

To Reassemble the Motor

Replace Field Core with Coils. After the insulating bushings are replaced; the field coil wires properly soldered to the brush tubes as shown at (R, Fig. 14) and brush tubes in place in insulating bushings (Z, Fig. 14), put field core (S, Fig. 14) in place on commutator end cover, being careful not to damage field coil insulation. When the field core is properly seated on commutator end cover, insert and tighten screws (A, Fig. 13).

Replace Armature. Before replacing the armature, make sure that the wires from the field coils to the brush tubes are safely positioned. Observe the wires through the field coils while the motor cover and armature are removed. If the wires are not properly placed (to avoid contact with armature or commutator) they can be reached through the field coils, with cover and armature removed.

When the armature was removed, as instructed on page 17, the spring-pressured grease wick for each of the two bearings (Y) projected into the shaft bearings. Therefore, before replacing the armature and shaft, remove the two grease wicks in order that armature shaft may be inserted in its bearings without damage to the wicks. To do this, remove cap screws (A, Fig. 15) and, using a small screw driver, carefully remove the grease wick spring retainer, together with grease wick spring and grease wick from each grease cup.

On the outer end of each grease wick retainer is a small tab the purpose of which is to hold the wick spring in place. **Do not**

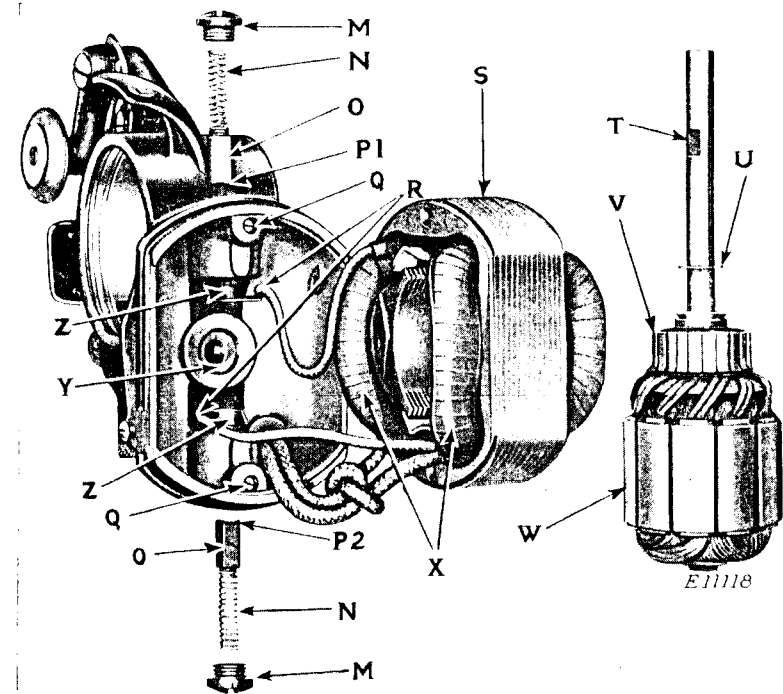

FIG. 14. MOTOR DISASSEMBLED

bend up these tabs to remove the wicks, as the tabs are very likely to break off at any attempt to bend them.

Put the spiral gear in position between the two bronze shaft bearings (Y, Fig. 13), having the two set screws (E, Fig. 13) toward the cap screw (H, Fig. 12) in order that one of the two screws (E) can engage the "flat" (T) on the armature shaft. Insert armature (W) so that the fibre washer (U) is against the first of the two shaft bearings (Y, Fig. 14).

When armature shaft is in place in its bearings and through spiral gear (D, Fig. 13), the "flat" (T), against which one of the two set screws (E, Fig. 13) is to be tightened, is covered. Its position is, however, indicated by the "flat" at (B, Fig. 13) at the cover end of the shaft. Be sure that one of the two screws (E, Fig. 13) engages the "flat" (T), then tighten both screws (E).

Replace the grease wicks, making sure that the inner ends of the wicks are against the armature shaft. Then put the grease

wick spring retainers in place in the grease cups, having the tab, at the outer end of each retainer, over the outer end of the grease wick spring. Fill the grease cups and replace cap screws (A, Fig. 15).

Replace Brushes. When inserting the brushes in the brush tubes, make sure that their concave ends (P1 and P2, Fig. 14) correspond with the convex surface of the commutator, and that they are replaced in the same relative position as before removal. See "Remove Brushes," page 16. Hold end of brush spring and tap the brush against the commutator until contact is clearly heard. Then insert and tighten the two screw caps (M, Fig. 14), being careful not to strip the threads.

Attach Motor, Three-Pin Terminal and Singerlight

Place motor frame, with motor assembled, on its seat on the machine arm, and insert and tighten the two screws (A, Fig. 12). Attach three-pin terminal to its bracket by inserting and tightening screw (F, Fig. 12). Attach Singerlight to machine arm by inserting and tightening screw (B, Fig. 12). Replace arm side cover. Replace the balance wheel as instructed on page 21.

To Lubricate the Motor

Remove the two thumb screws from the two grease cups (A, Fig. 15) and clean out the interiors of the cups. Insert the tip of motor lubricant tube into grease cups, as shown in Fig. 15, and squeeze about a quarter of the tube of lubricant into each cup, then replace and tighten the thumb screws.

Never, under any circumstances, use oil in the grease cups or on any part of the motor. Grease will remain in the bearings, but oil works its way onto the commutator and brushes, causing most of the troubles experienced with small motors—slow speed, failure to start, overheating, smoking, etc. These troubles may be remedied by removing the oil from the commutator, brushes and inner walls of brush tubes.

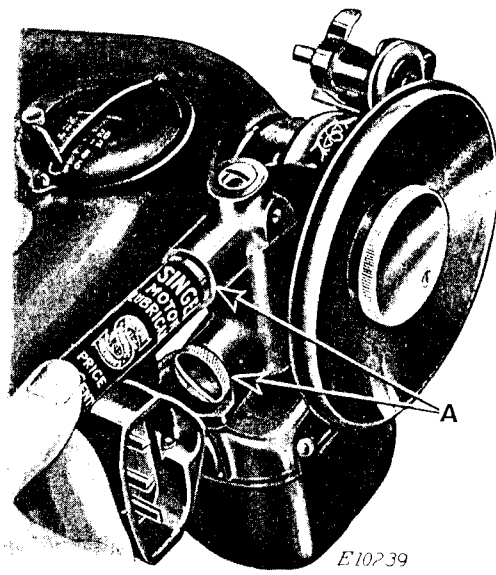

FIG. 15. LUBRICATING MOTOR

To Remove and Replace Balance Wheel

Loosen stop screw (A, Fig. 16) and remove clamp screw (B, Fig. 16) by unscrewing it. Remove balance wheel together with stop motion clamp washer (C, Fig. 16).

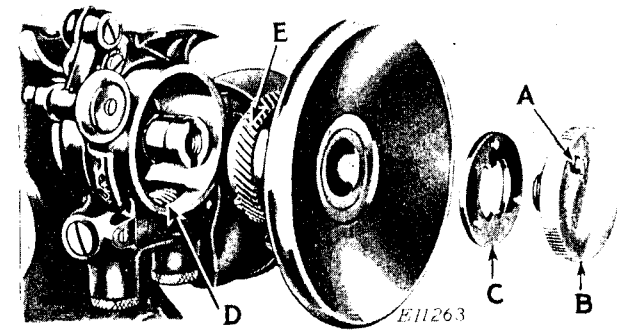

FIG. 16. BALANCE WHEEL REMOVED

When replacing the balance wheel, be careful not to injure the textolite gear (E, Figs. 16 and 17) when placing it in mesh with the spiral gear (D, Fig. 16) on the armature shaft. Replace stop motion clamp washer (C) so that when the stop screw (A) is tightened, it is a sufficient distance to the right of one of the three studs on the washer (C) to permit enough counter-clockwise rotation of the clamp screw (B) to stop sewing action of the machine during the winding of the bobbins.

NOTE:—The stop motion clamp washer on Machines 15-SS, 15-S9 and 15-90 is provided with three lugs instead of the studs referred to above.

To Remove and Replace Balance Wheel Textolite Gear and Shock-Absorbing Spring

Remove balance wheel in accordance with above instructions. Loosen the three set screws (G, Fig. 17) and remove balance wheel gear collar (F, Fig. 17) from the balance wheel hub. Then lift off the textolite gear (E, Fig. 17). Take off the spring retaining washer (P, Fig. 17). The shock-absorbing spring (O, Fig. 17) can then be removed from the recessed seat on the shoulder of the balance wheel hub. There are three pins in this recessed seat. The middle pin (N, Fig. 17) is for the right hand loop of spring (O, Fig. 17) as explained on the following page. The duty of the two outer pins is to prevent the two ends of spring (O, Fig. 17) from coming in contact with each other and thus becoming noisy during the functioning of this shock-absorbing spring. Make sure that these three pins are in place in the spring seat.

When replacing these parts, first put the shock-absorbing spring in position, as shown by Fig. 17, with the right hand loop of the

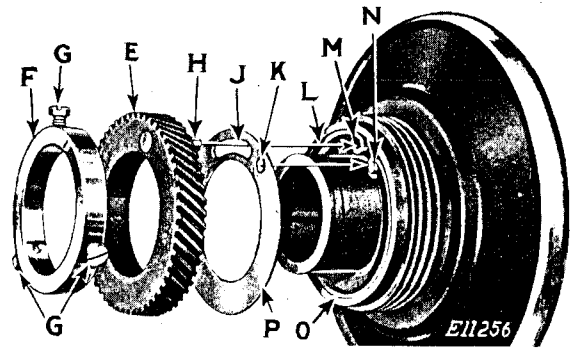

FIG. 17. BALANCE WHEEL DISASSEMBLED

spring about the middle pin (N, Fig. 17). Then place the spring retaining washer (P) so that the round pin hole (K) engages the pin (N) on which is placed the right hand loop of the shock-absorbing spring (O), as indicated by the unlettered arrow leading from pin-hole (K) to pin (N).

Next put in place the textolite gear (E) with the pin (H) through the slot (J) of the spring retaining washer (P), and into the left-hand spring loop (M), as indicated by the arrow (L).

BE SURE that the gear pin (H) engages the spring loop (M), as otherwise this shock-absorbing spring (O) will not function.

Replace the gear collar (F) which retains the textolite gear (E) in place on the balance wheel hub. This collar (F) should be so placed against the textolite gear (E) as to prevent side play, but not to retard the free oscillating movement of the gear during the functioning of the shock-absorbing spring. The use of a .003" feeler gauge or a piece of ordinary note paper, between gear collar and textolite gear, will establish the proper position of collar (F) relative to textolite gear (E). When collar (F) is properly positioned, tighten the three set screws (G).

Put the assembled balance wheel in place on the machine in accordance with "To Remove and Replace Balance Wheel" page 21.

To Remove and Replace the Shuttle

Turn the balance wheel over toward you until the needle is at its highest point, and the point of the shuttle is in the position indicated by (Q, Fig. 18).

Take out thumbscrew (R) to remove shuttle race back spring (S) and shuttle race back (T), then remove the shuttle.

Replace the parts in reverse order, viz: shuttle, shuttle race back (T), shuttle race back spring (S) and thumbscrew (R).

When replacing bobbin case, be sure to have its positioning finger (W) in the notch (V) of the position plate (U).

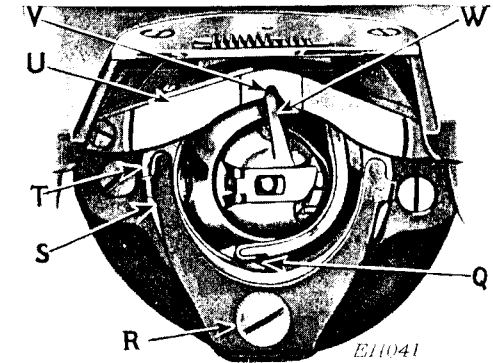

FIG. 18. CORRECT POSITION OF SHUTTLE FOR REMOVAL FROM MACHINE

To Time the Shuttle

The machine leaves the factory with shuttle driver (Z, Fig. 23) and oscillating shaft crank (J, Fig. 22) pinned to oscillating shaft (L, Figs. 22 and 23). Fig. 22 also shows positioning screw (N). The function of this screw (N) is to hold the crank (J) in proper relation to shaft (L) while the hole for pin (K) is drilled through crank hub and shaft. Timing is done at crank (J) after shuttle driver (Z, Fig. 23) has been pinned to the shaft as shown in Fig. 23.

Therefore the shuttle timing, as set at the factory, is permanent unless the machine subsequently sustains damage sufficient to affect the position of the shuttle driver.

When a replacement shuttle driver, or a replacement oscillating shaft crank is supplied (to replace the shuttle driver or oscillating shaft crank with which the machine is originally equipped), such parts are each provided with two screws for fastening to the oscillating shaft (L, Figs. 22 and 23). When both of these replacement parts are to be attached to the shaft, timing may be done either at the shuttle driver or at the oscillating shaft crank. In case replacement shuttle driver is to be attached (with oscillating shaft crank pinned to the shaft), it is necessary to time the shuttle by proper positioning of the new shuttle driver on the oscillating shaft, as follows:

Remove face plate, slide, presser foot, throat plate, feed dog, bobbin case, shuttle race back spring (S, Fig. 18), position plate (U, Fig. 18), shuttle race back (T, Fig. 18) and shuttle. Remove the old shuttle driver, as instructed on page 26, and remove, from it, shuttle driver cushion spring (B, Fig. 24) as instructed on page 28. Attach cushion spring (B, Fig. 24) to new shuttle driver as instructed on page 28, then attach the new shuttle driver to oscillating shaft in accordance with "To Remove and Replace Shuttle Driver," page 26. Put the shuttle in the shuttle race, and replace shuttle race back (T, Fig. 18) and shuttle race back spring (S, Fig. 18) as well as all other parts removed for this operation, with the exception of throat plate, slide, feed dog and position plate (U, Fig. 18) which, as a matter of convenience, are replaced after the timing of the shuttle as follows:

There are two timing marks on the needle bar.

Turn balance wheel over toward you until the **lower** mark is just visible at the lower end of the needle bar bushing as shown at (X, Fig. 19), when needle bar is on its upward stroke. When the needle bar is in this position, turn the new shuttle driver on oscillating shaft to bring the point of the new shuttle to centre of needle as shown at (Y, Fig. 19). **While setting shuttle point at centre of needle, make certain that the end of the cushion spring (B, Fig. 24) is not compressed by the heel of the shuttle (A, Fig. 24), toward or against the lower end of the shuttle driver.**

When the shuttle driver is properly positioned on the shaft, in accordance with above instructions, tighten the two screws (with which the new shuttle driver is provided) in the hub of the shuttle driver, while keeping the hub of the shuttle driver against the shaft bushing at (O, Fig. 23).

Replace the feed dog, position plate (U, Fig. 18), slide and throat plate.

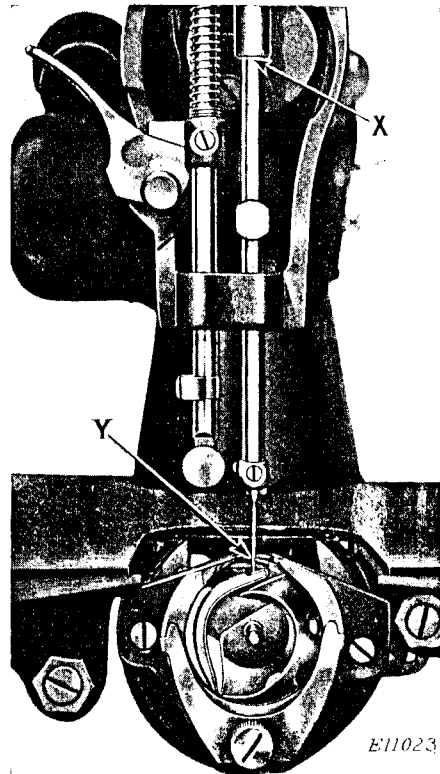

FIG. 19. SHUTTLE TIMING

To Set the Needle Bar at the Correct Height

When the needle bar reaches its lowest position, the **upper** of the two timing marks should be just visible at the lower

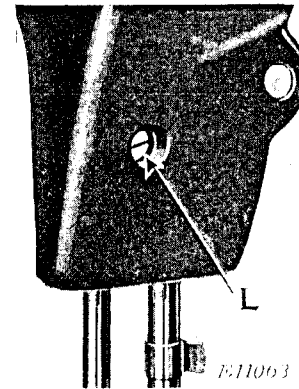

FIG. 20. SCREW TO ADJUST NEEDLE BAR HEIGHT

end of the needle bar bushing as shown by (D, Fig. 21). If this adjustment has been disturbed, turn the balance wheel over toward you to bring the set screw (L, Fig. 20) to a position where it is accessible through the hole at (I). Loosen screw (L) and have the needle bar connecting link (E) parallel with the needle bar when the thread take-up cam (C, Fig. 21) brings the upper end of the connecting link (E) to its lowest position as shown in Fig. 21. This is to obtain the lowest point in the needle bar action. Then set the needle bar with its **upper** timing mark just visible at the lower end of needle bar bushing as shown in Fig. 21. Tighten screw (L).

In case the position of the needle bar bushing has been disturbed, turn the balance wheel toward you until the point of the shuttle is at the centre of the needle and a scant $\frac{1}{16}$ inch above the top of the needle eye. Loosen screw (B) and move bushing up or down until its lower end is even with the **lower** timing mark at (X, Fig. 19). Tighten screw (B). See timing instructions on page 24.

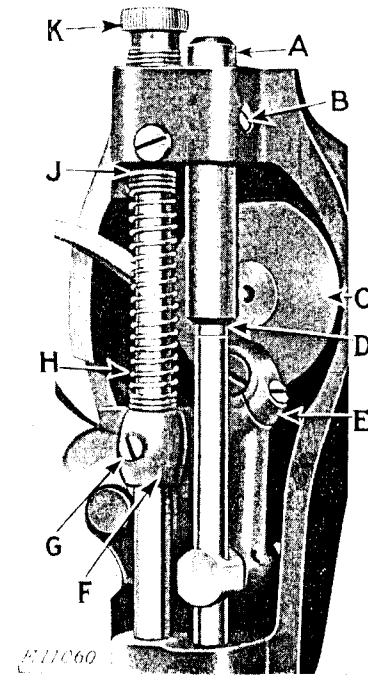

FIG. 21. NEEDLE BAR AT CORRECT HEIGHT

To Remove and Replace the Shuttle Driver

Remove the shuttle as instructed on page 23. Drive out the pin (K, Fig. 22) and loosen the positioning screw (N, Fig. 22).

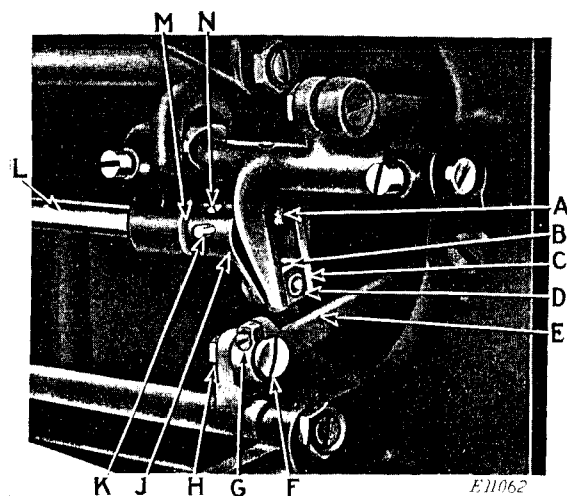

FIG. 22. TO RELEASE OSCILLATING SHAFT FROM OSCILLATING SHAFT CRANK

Remove the oscillating shaft (L, Figs. 22 and 23) with shuttle driver (Z, Fig. 23) attached, by drawing it to the left and out through the shuttle race body (P, Fig. 23).

After removal of oscillating shaft (L, Figs. 22 and 23) with shuttle driver (Z, Fig. 23) attached, drive out pin (R, Fig. 23) and take the shuttle driver off the shaft. Put the replacement shuttle driver on the shaft with face of shuttle driver flush with end of shaft as shown at (Y, Fig. 23) except that replacement shuttle driver has two fastening screws instead of a pin, as explained on page 23. The end of the shaft must not protrude beyond the face of the shuttle driver.

Turn the balance wheel toward you until the needle is up, then put the oscillating shaft (L, Figs. 22 and 23) in place in its bearings, and pin oscillating shaft crank (J) onto the oscillating shaft. Have the hub of the oscillating shaft crank (J) against shaft bearing at (M). Time the shuttle in accordance with instructions on page 24. Have the hub of the shuttle driver against shaft bearing at (O, Fig. 23) and tighten the two screws in the hub of the replacement shuttle driver. Replace the shuttle as instructed on page 23.

To Remove and Replace Oscillating Shaft Crank

Remove the shuttle as instructed on page 23. Disconnect the oscillating shaft crank (J, Fig. 22) from the oscillating shaft (L, Fig. 22) as instructed on page 26. Draw the oscillating shaft (L), with shuttle driver (Z) attached, to the left sufficiently to permit the removal of the crank (J, Fig. 22) from the shaft.

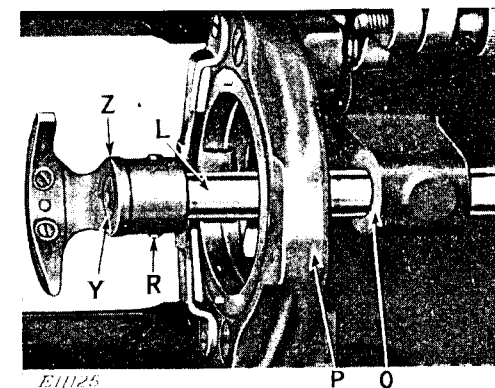

FIG. 23. OSCILLATING SHAFT PARTLY REMOVED

Put the replacement crank (which is provided with two screws instead of a pin) on the oscillating shaft, and see that the sliding block (D, Fig. 22) on the crank (J) is placed in the fork (C, Fig. 22) of the oscillating rock shaft so that the oil hole (B, Fig. 22) in the sliding block (D) faces the end of the lubricating wick (A, Fig. 22) in the oscillating rock shaft fork.

Time the shuttle in accordance with instructions on page 24, except that in this case the oscillating shaft is turned to bring the shuttle point in proper relation to the needle, instead of turning the shuttle driver on the shaft. Have the hub of the shuttle driver (Z) against the shaft bearing at (O), and tighten the two screws in the hub of the oscillating shaft crank (J) while having the hub of the crank against the shaft bearing at (M, Fig. 22). Replace the shuttle as instructed on page 23.

To Remove and Replace the Oscillating Shaft

Remove the shuttle as instructed on page 23, and oscillating shaft crank (J, Fig. 22) as instructed above. Remove oscillating shaft with shuttle driver attached (see Fig. 23) as instructed on page 26. Attach the shuttle driver as instructed on page 26, and place the shaft in its bearings. Attach oscillating shaft crank to the oscillating shaft as instructed above.

To Adjust Shuttle Driver Cushion Spring

To remove cushion spring (B, Fig. 24), take out the two screws (C). When replacing, put the hooked end (E) of the spring over

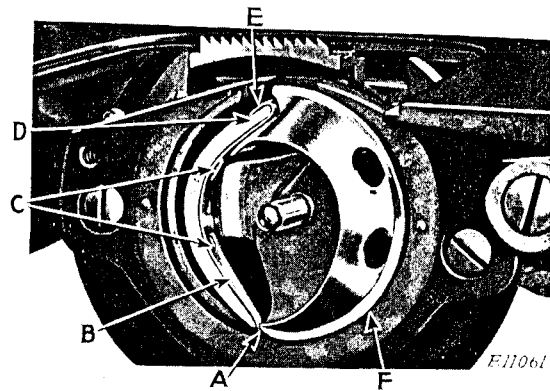

FIG. 21. SHUTTLE DRIVER CUSHION SPRING

the stepped end (D) of the shuttle driver, and insert and tighten the two screws (C).

The thread space between the heel of the shuttle (A) and the heel end of the spring (B) should be from .010 to .014 inch, spring not compressed.

If the end of the cushion spring (B) is too close to the heel of the shuttle at (A), incorrect thread tension, or thread breakage, is likely to result, especially on the larger sizes of thread, while if the distance between these two points is too great, unnecessary noise, at the shuttle, may develop in operation.

To Adjust the Presser Bar

With the presser bar lifter raised, there should be a clearance of $\frac{1}{16}$ inch between the presser foot and the throat plate. With the presser bar lowered, the presser foot should parallel the feed dog, and the needle should be close to (but not touch) the inner, or right hand, side of the large toe of the presser foot.

In case the presser bar and foot are not set as instructed, remove the face plate and raise the presser bar lifter. Then loosen presser bar bracket screw (G, Fig. 21) and raise or lower the presser bar until proper height is obtained; also make sure that the presser foot is parallel with the feed dog and that the needle is close to the inner, or right hand, side of the big toe of the presser foot. Securely tighten screw (G, Fig. 21) and replace the face plate.

To Raise or Lower the Feed Dog

The feed dog should be so adjusted that when it reaches its highest position, slightly less than the full depth of the feed dog teeth will project through the slots in the throat plate. The top of the feed dog teeth should be not more than $\frac{3}{64}$ inch above the top surface of the throat plate.

To raise or lower the feed dog, turn the balance wheel to bring the feed dog to its highest position; lay the machine on its rear side and screw in, as far as possible, thumb screw (C, Fig.

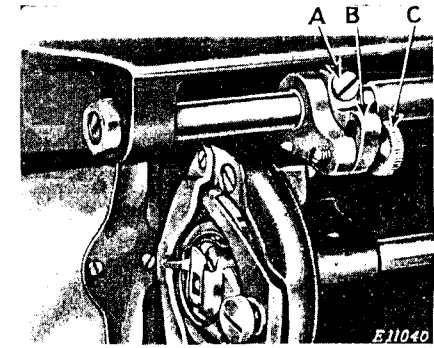

FIG. 25. TO RAISE OR LOWER FEED DOG

25). Loosen clamping screw (A) and turn the feed lifting rock shaft crank (B) up or down on the shaft until the feed dog is at the required height, viz: with the top of the feed dog teeth not more than $\frac{3}{64}$ inch above the top surface of the throat plate. Tighten clamping screw (A).

To Adjust the Position of the Feed Dog Lengthwise in the Feed Dog Slots in the Throat Plate

The feed forked connection hinge screw (eccentric) (F, Fig. 22) should be turned so that the high throw of the eccentric is toward the oscillating rock shaft (L, Fig. 22) to bring the centre row of feed dog teeth close to the needle hole end of the middle feed dog slot in the throat plate. Loosen clamping screw (G, Fig. 22) and loosen the nut (H, Fig. 22) on the eccentric screw (F, Fig. 22). Turn the eccentric screw (F, Fig. 22) until its high throw is toward the oscillating rock shaft (L, Fig. 22). Then tighten clamping screw (G, Fig. 22) and nut (H, Fig. 22).

To Adjust the Tension and Regulate the Action of the Thread Take-up Spring

The tension of the thread take-up spring (T, Fig. 26) should be just enough to take up the slack of the needle thread until the eye of the needle reaches the goods in its descent. Loosen set screw (R, Fig. 26) and turn the tension stud (O, Fig. 26)

to the right to increase the tension of thread take-up spring (T) or to the left to decrease the tension of this spring. When the correct tension is obtained, tighten set screw (R).

The height of action of thread take-up spring (T) is determined by the position of the recess (S) on the outer end of the thread take-up spring regulator (P). The upper end of this recess (S) acts as a "stop" for spring (T) at the desired height of spring action. If adjustment is required, loosen screw (Q) and turn the thread take-up spring regulator (P) to the right to lessen the height of spring action, or to the left to increase the height of spring action. When desired height of spring action is obtained, tighten screw (Q).

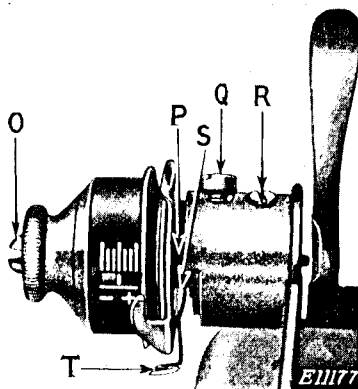

FIG. 26. THREAD TAKE-UP SPRING ADJUSTMENT

To Remove and Replace Thread Tension Parts

Thread tension parts can be removed in the following order, as shown in Fig. 27: Thumb nut (A), tension indicator (C), tension spring (D), tension indicator flange (E), tension releasing disc (F), tension discs (G and H), thread take-up spring thread guard (J).

Replace the parts by reversing the foregoing order of their removal, with the lug (M) of the thread guard (J) in the narrow recess (N) at the underside of

the thread guard seat. Have the pin (L) of the tension releasing disc (F) pointing away from the face plate so that it will engage one of the holes (K) in the tension indicator flange (E), with the projection (B) of indicator (C) in the graduated slot of the indicator flange (E).

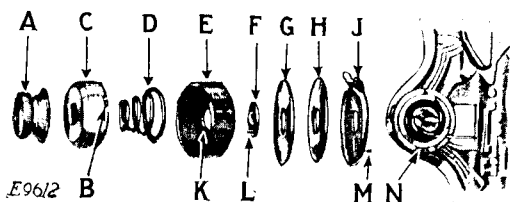

FIG. 27. THREAD TENSION PARTS REMOVED

To Adjust the Bobbin Winder

If the pressure of the bobbin winder pulley, against the hub of the balance wheel, is insufficient for winding the bobbin, press down the bobbin winder until the latch (A) drops down and holds it, then loosen the adjusting screw (F). With the forefinger, push back the upper end of the slotted plate (E), as far as it will go, as shown in Fig. 28, and, at the same time, press the bobbin winder pulley against the hub of the balance wheel, then tighten the adjusting screw (F).

If the thread does not wind evenly on the bobbin, loosen the screw which holds the tension bracket in position on the bed of the machine and slide the tension bracket to the right or to the left, as may be required, then tighten the screw.

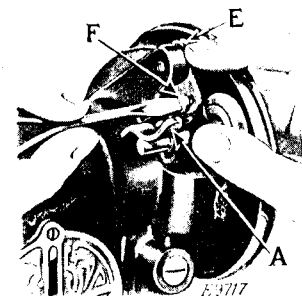

FIG. 28. ADJUSTMENT OF BOBBIN WINDER

To Remove and Replace the Arm Shaft

Remove face plate, and remove the presser foot and thread cutter from the presser bar. Loosen screw (G, Fig. 21) in the presser bar bracket. Push the presser bar up and out through the pressure regulating thumb screw (K, Fig. 21) together with the presser bar oiling wick in the pressure regulating thumb screw. This also removes the presser bar spring (H, Fig. 21), presser bar spring washer (J, Fig. 21) and presser bar bracket (F, Fig. 21). Remove pressure regulating thumb screw (K, Fig. 21).

Remove thread take-up lever hinge screw (N, Fig. 29) and thread take-up lever (O, Fig. 29).

Remove needle clamp and thread guard from the needle bar. Loosen needle bar set screw (L, Fig. 20) and push the needle bar up and out through the needle bar bushing (A, Fig. 21) together with the needle bar oiling wick in the bushing. Remove the needle bar connecting link (E, Fig. 21) from the thread take-up cam (C, Fig. 21). Loosen needle bar bushing set screw (B, Fig. 21) and, using a suitable brass rod, drive the bushing (A, Fig. 21) downward and out from the machine arm.

Remove balance wheel as instructed on page 21, and remove motor as instructed on page 16. Drive out the taper pin (Z, Fig. 30)

which fastens the clamp stop motion bushing (B2, Figs. 30 and 31) to the arm shaft. Remove the two cap screws (C2, Figs. 30 and 32) and the cap (D2, Figs. 30 and 32) from the connecting rod (W, Figs. 30 and 32). These two screws are accessible through the opening (E2, Fig. 30) in the top of the machine arm.

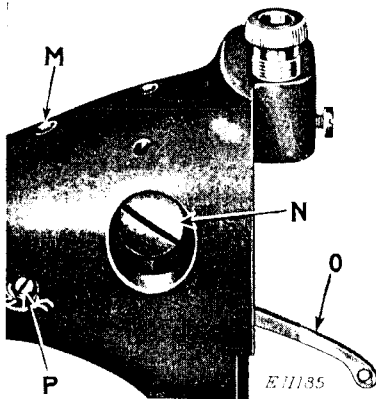

FIG. 29. TO REMOVE THREAD TAKE-UP CAM AND LEVER

Loosen clamping screw (G, Fig. 22) and remove nut (H, Fig. 22) and feed eccentric screw (F, Fig. 22) to disconnect the feed forked connecting rod (E, Figs. 30 and 32), and remove the feed forked connecting rod (E). Remove the feed regulator hinge screw (V, Figs. 30 and 32) which is accessible through the opening (Y, Fig. 31) in the machine arm, and remove the feed regulator (T2, Figs. 30 and 32).

Loosen the arm shaft bushing set screw (P, Fig. 29).

Loosen set screw (H2, Figs. 30, 31 and 32) in the feed cam and counterbalance (Q, Figs. 30, 31 and 32), and push the cam and

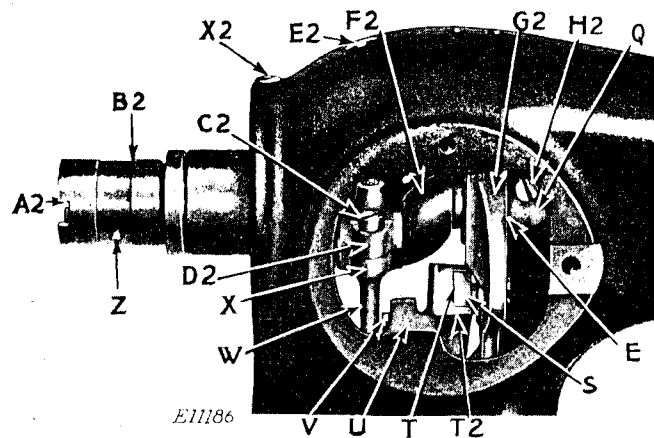

FIG. 30. ARM SHAFT ASSEMBLED AND IN PLACE IN MACHINE

counterbalance (Q) toward the thread take-up cam (N2, Fig. 32) as far as the V-groove (K2, Figs. 31 and 32) will permit.

Next place a suitable brass rod against the balance wheel end of the shaft at (A2, Figs. 30 and 31) and drive the shaft toward

the thread take-up cam (N2, Fig. 32) to start the removal of the clamp stop motion bushing (B2, Figs. 30 and 31).

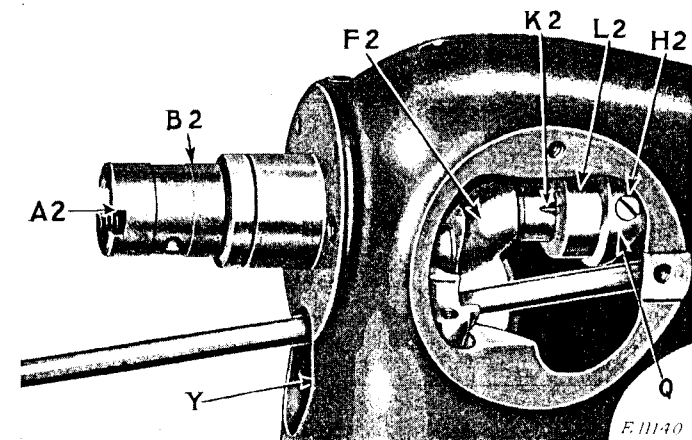

FIG. 31. DRIVING OUT THE SHAFT BUSHING

Then, while keeping the cam and counterbalance (Q) toward the thread take-up cam (N2), as shown in Fig. 31, insert a $\frac{1}{4}$ inch brass rod through the opening (Y, Fig. 31). Place the end of this brass rod against the bushing (P2, Fig. 32) and drive the bushing from its seat, after which the shaft, with thread take-up cam (N2), shaft bushing (P2) and cam and counterbalance (Q) can easily be removed. Driving out the shaft also completes the removal of clamp stop motion bushing (B2).

When replacing these parts, keep the cam and counterbalance (Q) toward the thread take-up cam (N2) in accordance with these instructions and as shown in Figs. 31 and 32, and have the oil hole (M2, Fig. 32) in the bushing (P2) in exact alignment with oil hole (M, Fig. 29) in the top of the machine arm. This will correctly locate the "flat" (O2, Fig. 32) on the bushing (P2) so that it is engaged by set screw (P, Fig. 29). Bushing (P2) is pushed into its seat by tapping lightly on the thread take-up cam end of the shaft. **Do not tap the face of the thread take-up cam (N2) as this would probably upset the thread take-up lever roller way in the cam.**

Before putting the balance wheel end of the shaft into the bearing at that end of the machine arm, be sure to press the oiling wick at (X2, Fig. 30) up into the oiling wick tube, using a small screw driver for this purpose. Otherwise the shaft will shear off the wick which, while shaft is removed, is forced into the shaft bearing by the oiling wick spring.

After the shaft is properly placed in the machine arm, carefully tap the clamp stop motion bushing (B2) in place on the

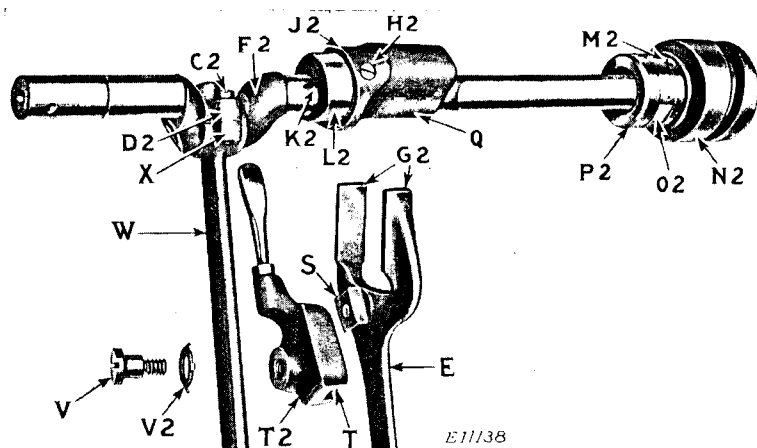

FIG. 32. SHAFT REMOVED FROM MACHINE

shaft, and fasten with the taper pin (Z, Fig. 30), making certain that the taper of this pin coincides with the taper of the hole through the bushing and shaft.

When fastening the connecting rod (W) to the shaft crank (F2), see that the cap (D2) is properly attached to the upper end (X) of the connecting rod (W). A shallow rib parallels the screw hole, through cap (D2) and cap end (X) of the connecting rod. This rib plainly indicates the correct position of the cap (D2) on the connecting rod at (X, Figs. 30 and 32). This rib is not shown in the accompanying illustrations. Note that if cap (D2) is attached in a reversed position, the connecting rod bearing will bind shaft crank (F2, Figs. 30, 31 and 32) instead of permitting it to turn freely.

Through the opening uncovered by the removal of the stitch indicator plate and cover, put the feed regulator (T2, Figs. 30 and 32) in place on its bracket (U, Fig. 30) and fasten by means of the hinge screw (V, Figs. 30 and 32) being sure that the three lugs of the friction washer (V2, Fig. 32) are against the bracket (U) and not against the head of the hinge screw (V). Tighten screw (V).

Move the cam and counterbalance (Q) to its original position as shown in Fig. 30, so that the cam (L2, Figs. 31 and 32) will be engaged by fork (G2, Figs. 30 and 32) of feed forked connecting rod.

With the sliding block (S) on its pin on the feed forked connecting rod (E, Figs. 30 and 32), place the fork (G2) in engagement with cam (L2) and have the sliding block (S) in the slideway (T, Figs. 30 and 32) of the feed regulator (T2). Fasten the lower end of the feed forked connecting rod (E) to the feed rock shaft by means of the eccentric hinge screw (F, Fig. 22) and the nut (H, Fig. 22), and adjust the position of the feed dog lengthwise in the slots in the throat plate in accordance with instructions on page 29. Tighten clamping screw (G, Fig. 22).

When the feed forked connecting rod (E) and the feed regulator (T2) are installed in the machine, the arm shaft should turn freely and with no binding or "drag." Binding would occur if the end of the cam and counterbalance (Q) were too close to the end of the shaft crank (F2), as the feed forked connecting rod (E) would then be "sprung" toward the shaft crank (F2). Therefore, be sure to position the cam and counterbalance (Q) so that the shoulder (J2, Fig. 32) does not press against that side of the fork (G2, Figs. 30 and 32) and, at the same time, without unnecessary "play" between that side of the fork (G2) and the shoulder (J2) of the cam. When cam and counterbalance (Q) is properly positioned, firmly tighten screw (H2).

Before replacing the needle bar bushing (A, Fig. 21), note the small hole or vent in the lower end of the upper—larger diameter—half of this bushing. When replacing the bushing (A, Fig. 21) be sure to have this vent directed straight back and toward the thread take-up cam (C, Fig. 21) so that any oil which may be sprayed from this vent (as the result of needle bar action) may serve to lubricate the upper end (E, Fig. 21) of the connecting link where it is connected to the thread take-up cam (C, Fig. 21).

Then set the needle bar bushing as instructed in the last paragraph of page 25.

Replace the needle bar by reversing the order of operations for its removal, under "To Remove and Replace Arm Shaft," page 31. Set for correct height as instructed on page 25.

Replace the presser bar by reversing the order of operations for its removal, page 31. Set the presser bar for correct height as instructed on page 28.

Replace the thread take-up lever and fasten it by means of hinge screw (N, Fig. 29).

Replace motor as instructed on page 20.

Replace balance wheel as instructed on page 21.

To Oil the Machine

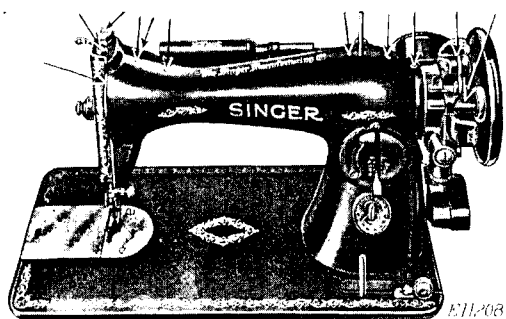

FIG. 33. FRONT VIEW, SHOWING OILING POINTS

To ensure easy running, the machine requires oiling and, if used continuously, it should be oiled each day. With moderate use, an occasional oiling is sufficient. Oil should be applied at each of the places indicated by arrows in Figs. 33 to 36, inclusive. One drop

of oil at each point is sufficient. Oil holes are provided in the machine for bearings which can not be directly reached.

Draw to the left the slide in the bed of the machine and, after removing the lint and dust which may have accumulated, apply oil to the shuttle race (F, Fig. 24).

Remove the arm side cover. Turn the balance wheel over toward you until the connecting rod (A, Fig. 34) is at its highest point. Then apply a few drops of oil, through the hole in the top of the machine, to the wick which is retained in the cap of the connecting rod, as shown in Fig. 34. Also oil the other moving parts inside.

Replace the arm side cover.

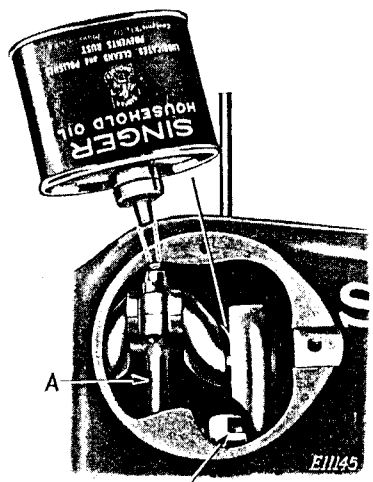

FIG. 34. OILING POINTS AT BACK OF MACHINE

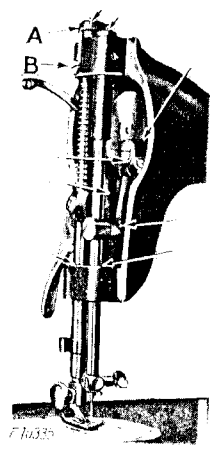

FIG. 35. END VIEW, SHOWING OILING POINTS

Loosen the screw (B, Fig. 35) to remove the face plate.

Apply one drop of oil at each of the places indicated by arrows in Fig. 35.

Replace the face plate.

Also apply oil to the oil holes and bearings, indicated by the arrows in Fig. 36, in the bed of the machine.

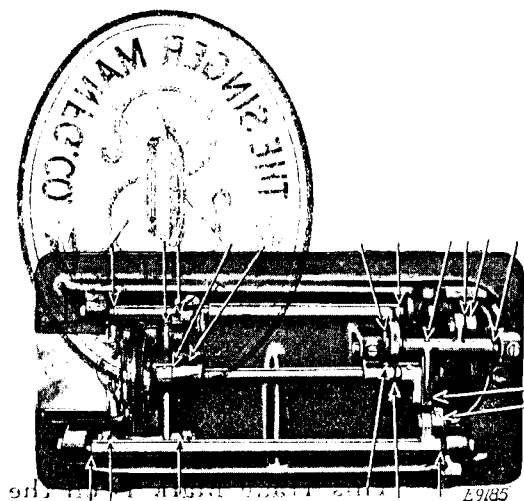

FIG. 36. OILING POINTS IN BED OF MACHINE